



THERMO65 / THERMO46 ENTRANCE DOORS

NEW. Double-leaf entrance door Thermo65 and elegant glazing with black glass







04

Good reasons to try
Hörmann

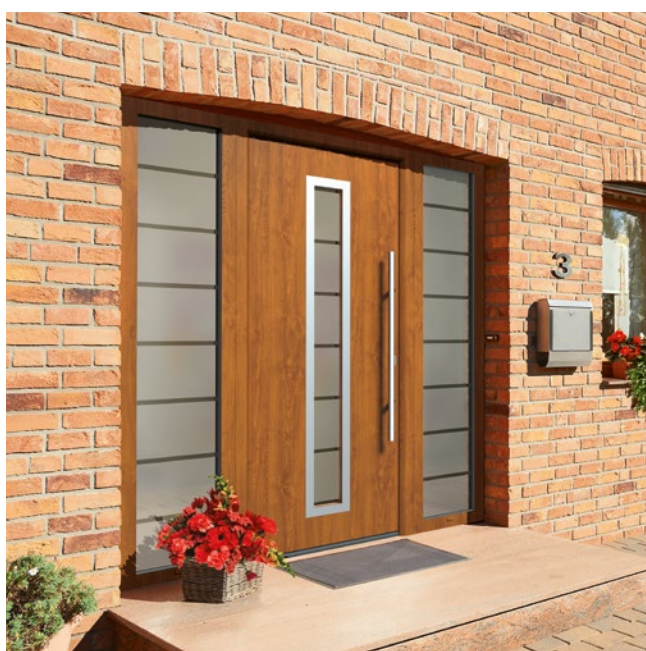

14

Door styles
Inspirations



28

Design
Equipment
Accessories

Responsibility for generations

The Hörmann family business has over 85 years of experience as a construction component specialist. This gives us an obligation to both current and future generations. That's why environmental responsibility plays such an important role for us. With this in mind, we develop innovative solutions for sustainable products and intelligent environmental protection.



“A GOOD REPUTATION MUST BE EARNED.”

August Hörmann

In keeping with the tradition started by the company's founder, the Hörmann brand is a true promise of quality and, with sales of over 20 million doors and operators, is one of Europe's most successful suppliers. Due to the comprehensive international sales and service network, Hörmann is your strong partner for high-quality construction components.

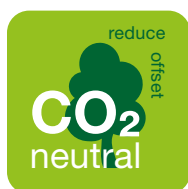

WE THINK AND ACT GREEN. As a family business, we are very conscious of our responsibility to future generations. The Hörmann climate protection strategy aims to reduce and avoid CO₂ emissions. We cover 100% of our electrical power needs at all European production locations with purchased green electricity. We are also investing in a clean future with other measures such as the use of recycled paper, CO₂-neutral postal shipping and the recycling of transport packaging to save more than 75,000 tons of CO₂ every year. We work with ClimatePartner to offset the emissions that we do generate by supporting certified climate protection projects. In particular, we offset all CO₂ emissions produced in manufacture of products for residential construction as standard.



ClimatePartner
certified product
climate-id.com/XNEBKC

CO₂
measure
reduce
contribute

Brand quality made in Germany



The family-owned company Hörmann offers all important construction components for building and renovating projects from a single source. We manufacture in highly specialised factories using state-of-the-art production technologies. Our employees work intensively on new products, continual further developments and improvements to details. The results are patents and one-of-a-kind products you can depend on.





5-year warranty

LONG-LASTING. GUARANTEED. All major door components are developed and manufactured by Hörmann. Endurance tests under real conditions ensure mature series products with Hörmann quality. Thanks to this and uncompromising quality assurance, you receive a 5-year warranty on all Hörmann entrance doors Thermo65 / Thermo46.



Only from Hörmann

Acoustic-rated doors with thermal break



Only from Hörmann

Fire-rated doors with thermal break

CONVINCING IN EVERY VERSION. Our entrance doors are superior to plastic or timber doors in many ways. When it comes to thermal insulation, all of our entrance doors meet the requirements of the new German Buildings Energy Act (GEG). Our acoustic-rated doors also reduce street noise to room level and our fire-rated doors are the ideal choice for between the garage and your living space.

→ For further information, see from page 30.



Door design for the highest demands

Greet your guests with a Hörmann entrance door! And of course, you and your family can also delight in the sophisticated design of our doors day after day. Our doors are a true eye-catcher on the outside, and inside they harmonise perfectly with your residential internal doors. Simply beautiful!





DOOR LEAF WITHOUT VISIBLE LEAF PROFILE.

Thermo65 and Thermo46 doors make for an exquisite and elegant reception – whether you use them for your main or a side entrance. The shapely door leaf with its solid interior and exterior and leaf profile on the inside fulfils the highest design requirements. The interior view harmonises perfectly with your residential internal doors.

TOP. Exterior and interior view of Hörmann entrance doors without visible leaf profile

BOTTOM. Exterior and interior view of entrance doors from other manufacturers with visible leaf profile

PAGE 8. Steel / aluminium entrance door Thermo65 style 515, stainless steel handle HB 38-2, Matt deluxe Grey aluminium CH 9007, optional side elements

We protect you from unwanted visitors

An apartment is broken into every five minutes, making it even more important to equip your entrance door with a high security standard. If a burglar is not successful within approx. 90 seconds, they generally give up their break-in attempt. For this reason, nearly half of all break-in attempts fail if the entrance door is break-in-resistant.





BREAK-IN-RESISTANT LOCKING. For you and your family, being able to rest easy in your own home is important. This is why our Thermo65 / Thermo46 doors are equipped with multiple-point locking as standard. And with the standard crank or soft lock latch, the doors also close very quietly.



RC2 security
Optional



Tested and certified

FOR INCREASED SECURITY. With the optional RC2 security features, our entrance doors make it especially difficult for burglars to break into your home. This protects your home from break-in attempts. Additionally, the certified security features are not visible on the door, unlike with many competitor solutions.

→ For further information, see from page 30.

Entrance doors tailored to your specifications

Whether you want a new entrance door or a door for you side entrance: The Hörmann range is designed to meet your needs. We offer you doors tailored to your exact wishes. Whether with an elegant look, large glazings or intelligent operating comfort – anything is possible, exactly the way you want it. Be inspired by the Hörmann variety on the following pages or configure your dream door conveniently online.





20% incentive possible

TAX INCENTIVES that save you money. In Germany, certain circumstances allow you to offset 20 per cent of your new entrance door purchase over three years.

THE DOOR OF YOUR CHOICE IN JUST A FEW CLICKS. With the door configurator, you can conveniently test many design and product variants on your own PC or tablet in advance. You can put your dream entrance door together in just a few clicks by selecting the door version, style, colour and size and also see the recommended retail price of your configuration. If you then upload a picture of your house and place the door in your entrance, you can see in advance how well your new entrance door will match your home.



Thermo65



RC2 security
Optional



High thermal insulation
U_D-value of up to 0.87 W/(m²·K)

THE PERFECT ENTRANCE TO YOUR HOME.

Choose from modern and classic styles, with and without glazing to find the entrance door that best suits your home. For perfect harmony with your white residential internal doors, the inside of the door is optionally available in Traffic white RAL 9016 for a wide range of styles, colours and surface finishes.

→ For further information, see from page 37.

Enjoy greater clear passage width for pushchairs, wheelchairs, etc. The double-leaf entrance doors also impress with an elegant, flush-fitting transition from the traffic leaf to the fixed leaf.

Styles 010, 610S (shown) and 700B are also available as double-leaf entrance doors



LEFT. Steel / aluminium entrance door Thermo65 style 610S, stainless steel handle HB 38-2, glazing with satin-finished glass, Anthracite grey RAL 7016, optional side element



Style 010
With embellishment view 751



Style 010



Style 010
With embellishment view 750



Style 015
With embellishment view 400



Style 015



Style 515
With embellishment view 401



Style 515

THERMO65

All door styles on this double-page spread in Matt deluxe CH 703 Anthracite Metallic

Style 010 stainless steel embellishment view 751 (optional), stainless steel handle HB 14-2

Style 010 stainless steel handle HB 14-2, side element with glazing with satin-finished glass, also available as double-leaf version

Style 010 with embellishment view 750 in stainless steel look (optional), stainless steel handle HB 14-2

Style 015 with embellishment view 400 in stainless steel look (optional), stainless steel handle HB 14-2

Style 015 stainless steel handle HB 14-2

Style 515 with embellishment view 401 in stainless steel look (optional), stainless steel handle HB 14-2

Style 515 stainless steel handle HB 14-2

→ You will find all colours and surface finishes from page 34.



Style 610S



Style 610N



Style 630S



Style 700B



Style 700N



NEW. Style 700P



Style 730B



Style 750C

THERMO65

All door styles on this double-page spread in Matt deluxe CH 703 Anthracite Metallic

Style 610S stainless steel handle HB 38-2, glazing with satin-finished glass, also available as double -leaf version

Style 610N stainless steel handle HB 38-2, glazing with one-way plate glass

Style 630S stainless steel handle HB 38-2, glazing with satin-finished glass

Style 700B stainless steel handle HB 38-2 and stainless steel glazing frame, sand-blasted glazing with 7 clear stripes, also available as double-leaf version

Style 700N stainless steel handle HB 38-2 and stainless steel glazing frame, glazing with one-way plate glass

Style 700P stainless steel handle HB 38-2 and stainless steel glazing frame, black.edition Jet black RAL 9005 (optional), **NEW.** Glazing with black glass

Style 730B stainless steel handle HB 38-2, sand-blasted glazing with 7 clear stripes

Style 750C stainless steel handle HB 38-2, sand-blasted glazing with 5 clear stripes

→ You will find all colours and surface finishes from page 34.



Style 800S



Style 810E



Style 810N



Style 820S



Style 830S



Style 840S



Style 850B



Style 900D

THERMO65

All door styles on this page in Grey aluminium RAL 9007

- Style 800S** stainless steel handle HB 38-2, glazing with satin-finished glass
- Style 810E** stainless steel handle HB 38-2, sand-blasted glazing with clear stripes (square)
- Style 810N** stainless steel handle HB 38-2, glazing with one-way plate glass
- Style 820S** stainless steel handle HB 38-2, glazing with satin-finished glass
- Style 830S** stainless steel handle HB 38-2, glazing with satin-finished glass
- Style 840S** stainless steel handle HB 38-2, glazing with satin-finished glass
- Style 850B** stainless steel handle HB 38-2, sand-blasted glazing with 7 clear stripes
- Style 900D** stainless steel handle HB 38-2, sand-blasted glazing with 4 clear stripes

→ You will find all colours and surface finishes from page 34.



TOP: Steel / aluminium entrance door Thermo65 style 100, stainless steel handle HB 14-2, Terra brown RAL 8028, optional side elements, S-panelled sectional garage door, Woodgrain, Terra brown RAL 8028



Style 100



Style 410S



Style 430E

THERMO65

All door styles on this page in Terra brown, RAL 8028

Style 100 stainless steel handle HB 14-2, side elements with glazing with satin-finished glass

Style 410S stainless steel handle HB 14-2, glazing with satin-finished glass

Style 430E stainless steel handle HB 14-2, sand-blasted glazing with clear stripes (frame)

→ You will find all colours and surface finishes from page 34.

Custom entrances

You can custom-equip each of the entrance door styles. You want a special external handle or glazing? We offer all the options you need to give your entrance door a personal touch. For more light in your home, you can add side elements and transom lights to any of the door styles shown. Special door versions are also possible, such as doors opening outwards. At Hörmann, you are sure to find the entrance door to suit your home.

→ For further information, see from page 38.

TOP LEFT.

Steel / aluminium entrance door Thermo65, interior in Traffic white RAL 9016, matching white residential internal doors, optional side elements, optional SmartKey

TOP RIGHT.

Steel / aluminium entrance door Thermo65 style 700B, sectional garage door L-ribbed, Planar CH 703 Matt deluxe

BOTTOM LEFT.

Steel / aluminium entrance door Thermo65 style 010, stainless steel handle HB 14-2, Anthracite grey RAL 7016, optional side elements, opening outwards

BOTTOM RIGHT.

Steel / aluminium entrance door Thermo65 style 010, stainless steel handle HB 38-2, Decograin Golden Oak, optional side elements





PERSONAL DESIGN. When choosing a colour for your new Hörmann entrance door, we let your creativity run wild with 10 Color, 10 MatchColor and 7 Matt deluxe colours as well as 5 Decograin decors. The interior and exterior are generally delivered with a matching appearance. Optionally, you can order many Thermo65 entrance doors in Traffic white RAL 9016 on the inside to perfectly match your white residential internal doors.

MATCHING ENTRANCE AND GARAGE DOORS. For a harmonious overall look of doors and garage doors, choose from 10 MatchColor preferred colours, detailed and natural Decograin decors as well as the Hörmann Matt deluxe colour – matching the colour of Hörmann sectional garage doors with L-ribbing and Planar surface finish. This allows you to design your entrance door, sectional garage door, side door and steel door in a matching colour. Enjoy this coordinated look for a lifetime.

→ For further information, see from page 34.

Radio door lock operator SmartKey

Easily open your door lock at the press of a button with your hand transmitter, radio internal push button or directly via the sensor field on the SmartKey. No need to set down your groceries in order to open your entrance door. Even with a walker, wheelchair or pram, it is much easier to enter your house because you can open the door from a distance. Locking takes place either by pressing a button or automatically after a specified period of time. This securely locks your door and provides protection against burglary.

→ For further information, see from page 40.





TOP RIGHT. Hörmann homee Smart Home control centre for all areas of your home

BOTTOM RIGHT. Convenient door opening with a smartphone

BOTTOM. Radio door lock operator SmartKey for simple door locking and unlocking

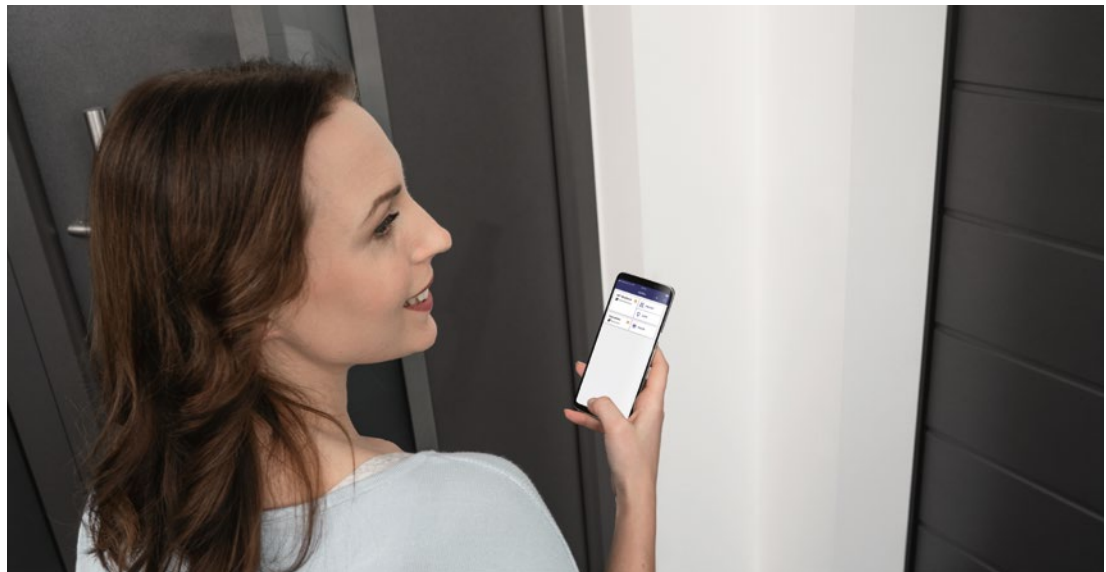

Operating comfort for young and old

Open your entrance door easily and conveniently with our smart solutions. By code, fingerprint, hand transmitter or smartphone. With our lock packages, you are sure to find an intelligent solution that meets your needs. With the Hörmann homee Smart Home control centre, you can conveniently control your Hörmann garage and entrance gate, as well as climatic sensors or a camera all with an app. At any time of day or night, from anywhere around the world.

→ For further information, see from page 40.



HORMANN

Thermo46

**RC2 security**

Optional

**Good thermal insulation**U_D-value of up to 1.1 W/(m²·K)**IDEAL FOR YOUR SIDE ENTRANCE.**

Steel / aluminium entrance door Thermo46 is the right choice for a side door for your home. Combined with a residential internal door as a vestibule, you can also use the Thermo46 in your entrance. We offer our entrance doors in many styles, from classic to modern, with or without glazing.

As standard, the Thermo46 doors are delivered with the same interior and exterior, meaning that the colour and surface finish on the outside and inside match.

Thermo46 doors offer you everything you expect from an excellent entrance door. Select a style to match your home!

LEFT. Steel / aluminium entrance door
Thermo46 style 700B, stainless steel
handle HB 38-2, Traffic white
RAL 9016, optional side element



Style 010

Style 515
With embellishment view 400

Style 700B



Style 750C



Style 015

Style 025S
With embellishment view 400

Style 020S



Style 030S

THERMO46

All door styles in the top row in Anthracite grey RAL 7016. All door styles in the bottom row in Traffic white RAL 9016

Style 010 stainless steel handle HB 14-2

Style 515 with embellishment view 400 in stainless steel look (optional), stainless steel handle HB 14-2

Style 700B stainless steel handle HB 38-2, sand-blasted glazing with 7 clear stripes

Style 750C stainless steel handle HB 38-2, sand-blasted glazing with 5 clear stripes

Style 015 stainless steel handle HB 14-2

Style 025S with embellishment view 400 in stainless steel look (optional), stainless steel handle HB 14-2, glazing with satin-finished glass

Style 020S stainless steel handle HB 14-2, glazing with satin-finished glass

Style 030S stainless steel handle HB 14-2, glazing with satin-finished glass

→ You will find all colours and surface finishes from page 34.



Style 900D



TOP. Steel / aluminium entrance door Thermo46 style 400I, stainless steel handle HB 14-2, glazing with Kathedral glass, Traffic white RAL 9016, optional side elements



Style 100



Style 200I



Style 400I

THERMO46

The door style in the top row in Anthracite grey RAL 7016. All door styles in the bottom row in Traffic white RAL 9016

Style 900D stainless steel handle HB 38-2, sand-blasted glazing with 4 clear stripes

Style 100 stainless steel handle HB 14-2

Style 200I stainless steel handle HB 14-2, glazing with Kathedral glass

Style 400I stainless steel handle HB 14-2, glazing with Kathedral glass

→ You will find all colours and surface finishes from page 34.



30



38

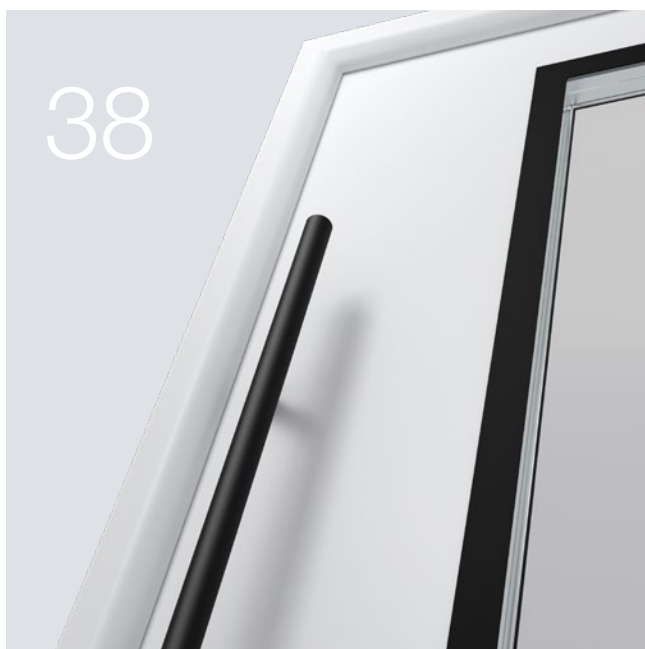

40



Design Equipment Accessories

- 30 Door versions
- 32 Door equipment
- 34 Colours and decors
- 37 Customisation
- 38 Frames and glazings
- 39 Exterior handles and lever handle sets
- 40 Automatic locks and electric extras
- 42 Dimensions and technical manual

Door versions

The right profile for any requirement

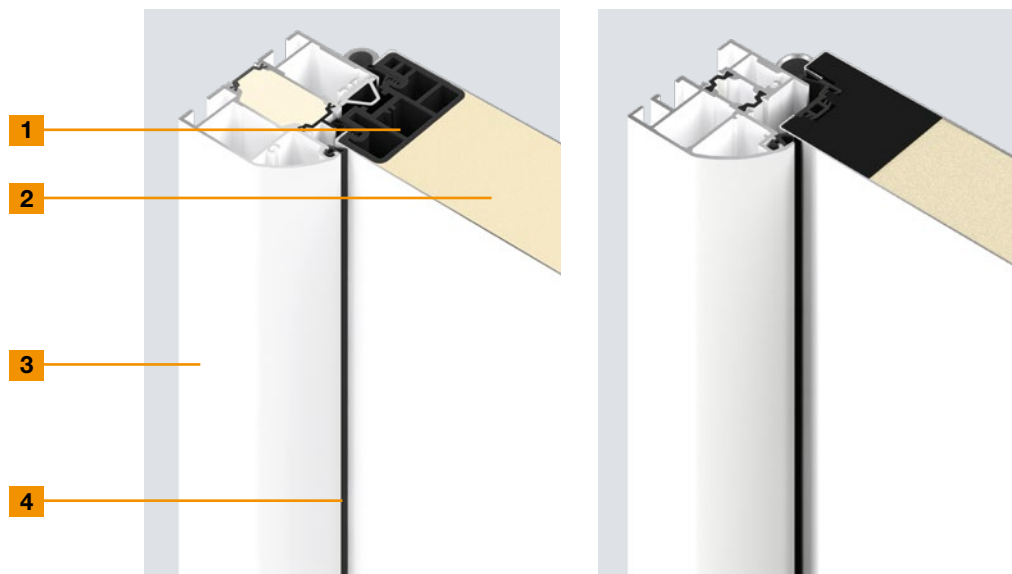

	Thermo65	Thermo46
1 Door profile	Interior	Interior
Material	Compound material	Compound material
2 Door leaf thickness	65 mm	46 mm
Internal and external sheet	Steel, with thermal break	Steel, with thermal break
3 Door frame	Rounded door frame A3, 80 mm	Rounded door frame A1, 60 mm
Material	Aluminium, with thermal break	Aluminium, with thermal break
4 Sealing system	triple	double
Threshold	Aluminium / plastic (standard, S11), plastic (optional, S12)	Aluminium / plastic
Performance characteristics		
Operating forces EN 12217	Up to class 3	Up to class 2
Long-term functionality / mechanical load EN 12400	Up to class 6	Up to class 5
Differential climate behaviour EN 12219	Up to 2d / 2e	Up to 3c / 2d / 2e
Air permeability EN 12207	Up to class 4	Up to class 2
Water tightness under heavy rain EN 12208	Up to class 3A	Up to class 1A
Resistance to wind load EN 12210	Up to class C3 / B3	Up to class C3
Impact resistance EN 13049	Up to class 1	Up to class 1
Mechanical strength EN 1192	Up to class 3	Up to class 1
Thermal insulation	Up to 0.87 W/(m²·K)	Up to 1.1 W/(m²·K)
Acoustic insulation	Up to 42 dB	Up to 32 dB
Burglar protection EN 1627 (optional)	RC2 security features (optional)	RC2 security features (optional)

Frame variants

Entrance doors Thermo65 and Thermo46 are optionally also available with an angular door frame at no surcharge.

- 5** Thermo65 door frame A4
- 6** Thermo46 door frame A2



RC2 security
Tested and certified

Security doors

The opportunist burglar attempts to break open the locked door with simple tools within 3 minutes.



Acoustic-rated
Up to 42 dB

Acoustic-rated doors

You can use Thermo65 styles 010, 610S and 610N as acoustic-rated doors. With the standard threshold, the doors achieve acoustic rating category 3 (42 dB) and acoustic rating category 2 (37 dB) with the optional retractable bottom seal. They provide protection against street noise as well as wind and weather: the ideal solution – not only for entrance doors in blocks of flats with walkways.



Fire-retarding
EI₂30

Fire-rated doors

The fire-rated doors Thermo65 styles FSTHP 010 and FSTHP 610 can withstand a fire for at least 30 minutes, making them the ideal solution for between the garage and your living space (e.g. entrance hallway). They also offer good thermal insulation for this sensitive area.

Only from Hörmann
Acoustic-rated doors with thermal break

Only from Hörmann
Fire-rated doors with thermal break

Door equipment

For an elegant, functional door design



Thermo65

Thermo46

	Thermo65	Thermo46
1 Solid door view from the inside	●	●
2 5-point security lock with soft lock latch		●
3 5-point security lock with crank latch	●	
Automatic lock with mechanical self-locking	○	
4 Continuous security strip made of aluminium	●	
5 3 security bolts		●
6 3-way adjustable guide rollers	●	●
7 Stainless steel interior lever	●	●
8 Security push-on rose escutcheon	●	○
9 Profile cylinder with emergency and hazard function and 5 keys as standard	●	●
10 Door drip	○	○
11 Retractable bottom seal	○	○
12 Mechanical hold-open device	○	○

● = As standard ○ = Optional



4



7



10



5

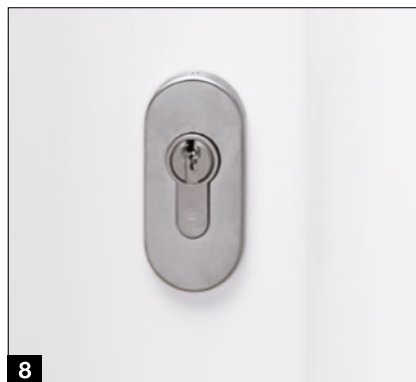

8



11



6



9



12

Retractable bottom seal (not shown)

This optional equipment is the best solution for sealing entrance doors without threshold used for barrier-free entrances.

Door drip

Attractive protection: The door drip in White aluminium RAL 9006 **10** or in stainless steel **11** diverts driving rain and can also be easily retrofitted.

12 Mechanical hold-open device

The open door leaf can be easily fixed in place with the optional mechanical hold-open device. This way, you don't have to worry about your entrance door closing by itself.

Colours

MatchColor, Color, standard

MatchColor

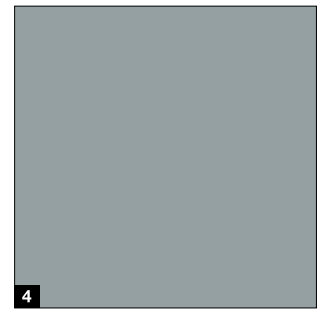
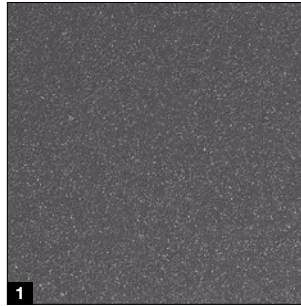

MatchColor

MatchColor

Design your home in perfect colour harmony – with the MatchColor preferred colours for matching sectional garage doors, entrance doors, side doors and steel doors. Enjoy the harmonious overall look thanks to matching colours. That is Hörmann brand quality!

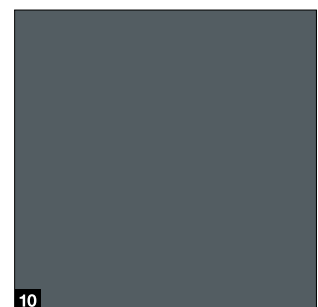
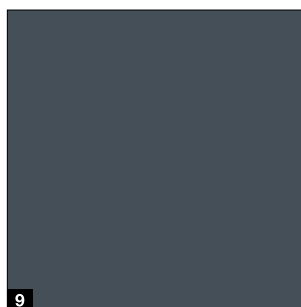
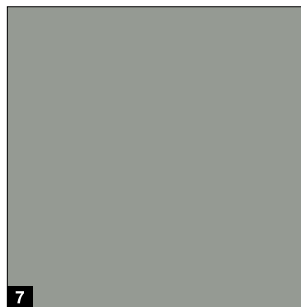
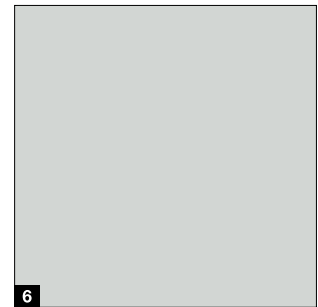
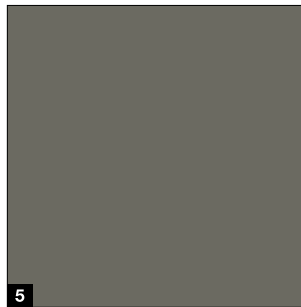

Standard and Color

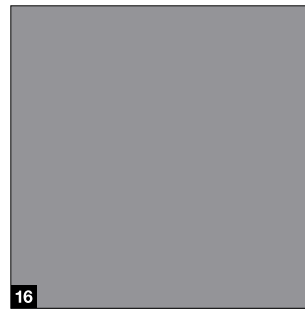
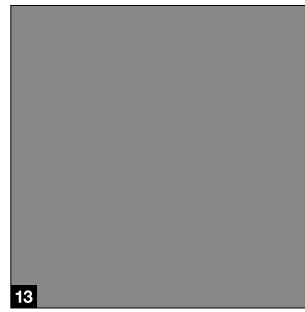
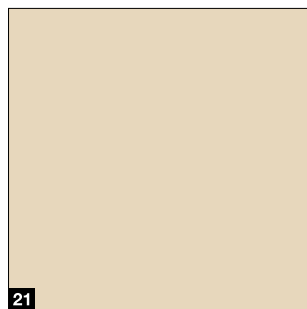
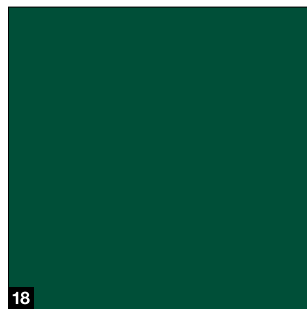
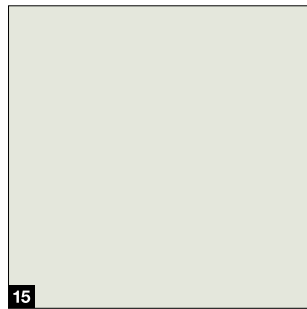
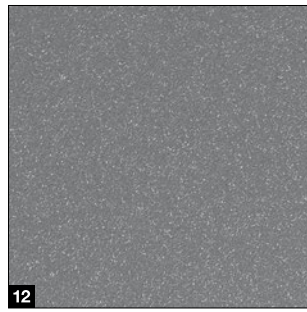
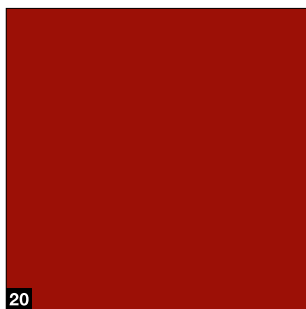
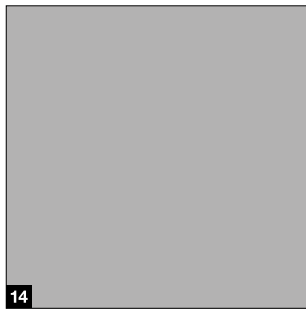

MatchColor

- 1 CH 703 Anthracite Metallic
- 2 RAL 9005 Jet black
- 3 RAL 8028 Terra brown
- 4 RAL 7040 Window grey
- 5 RAL 7039 Quartz grey
- 6 RAL 7035 Light grey
- 7 RAL 7030 Stone grey
- 8 RAL 7016 Anthracite grey
- 9 RAL 7015 Slate grey
- 10 RAL 7012 Basalt grey

Standard

- 11 RAL 9016 Traffic white

Color

- 12 CH 907 Grey aluminium
- 13 RAL 9007 Grey aluminium
- 14 RAL 9006 White aluminium
- 15 RAL 9002 Grey white
- 16 RAL 7037 Dusty grey
- 17 RAL 6009 Fir green
- 18 RAL 6005 Moss green
- 19 RAL 5010 Gentian blue
- 20 RAL 3003 Ruby red
- 21 RAL 1015 Light ivory

Please note:

All colours based on RAL. The colours and surface finishes shown are subject to the limitations of the printing process and cannot be regarded as binding. **Please consult with your local Hörmann sales partner.**

Other colours and decors

Matt deluxe colours and Decograin decors

Matt deluxe

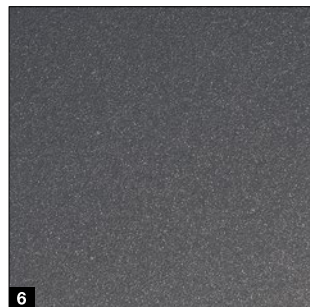
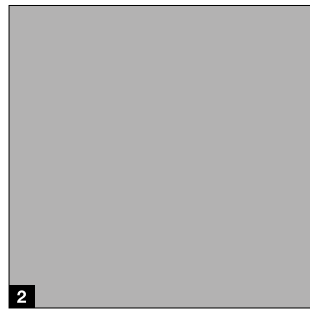
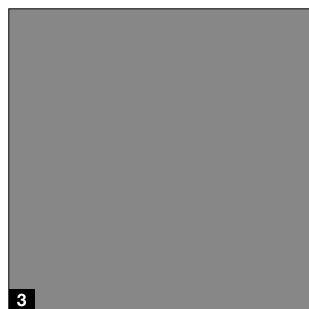
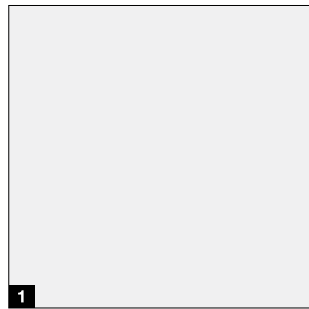

Decograin decors*

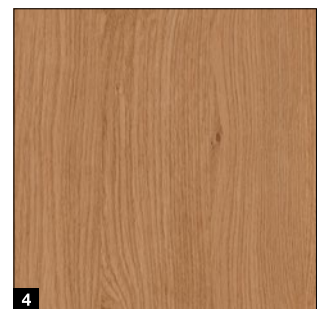
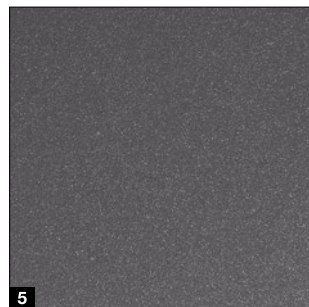
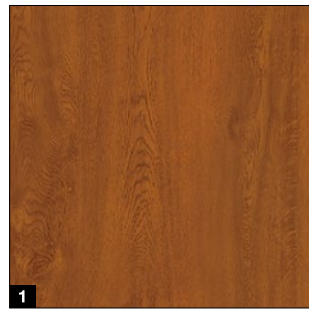

- 1** CH 9016 Matt deluxe Traffic white
- 2** CH 9006 Matt deluxe White aluminium
- 3** CH 9007 Matt deluxe Grey aluminium
- 4** CH 8028 Matt deluxe Terra brown
- 5** CH 7016 Matt deluxe Anthracite grey
- 6** CH 703 Matt deluxe Anthracite Metallic
- 7** CH 905 Matt deluxe black

- 1** Golden Oak: medium brown, golden yellow oak decor
- 2** Dark Oak: walnut-coloured oak decor
- 3** Night Oak: dark, intense oak design
- 4** Winchester Oak: natural-coloured knotty oak decor
- 5** Titan Metallic CH 703: Anthracite with a metallic effect

Please note: The colours and surface finishes shown are subject to the limitations of the printing process and cannot be regarded as binding. Dark colours should not be used for doors that are exposed to the sun, as an increased material expansion may impair the door's function. **Please consult with your local Hörmann sales partner.**

* Not available for Thermo65 / 46 styles 100, 200, 400, 410, 430, 610 and 630.

Customisation

Design your entrance door to fit your needs

Embellishments

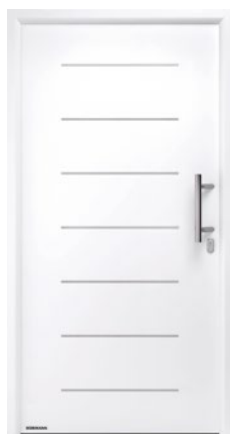

Style 015, view 400



Style 515, view 401



Style 025, view 402



Style 015, view 403



Style 010, view 451



Style 010, view 454



Style 010, view 457



Style 010, view 459



Style 010, view 750



Style 010, view 751

Door leaf and frame in different colours

Give your entrance door an individual look and combine the door leaf and frame in different colours for Thermo65 and Thermo46 entrance doors.



Door frame in White aluminium RAL 9006, door leaf in Titan Metallic CH 703



Door frame in Titan Metallic CH 703, door leaf in Traffic white RAL 9016



Viewed from outside with Decograin surface finish



Viewed from inside in Traffic white RAL 9016¹⁾

Two-colour entrance doors and side elements

The Thermo65 entrance doors¹⁾ in the colours Anthracite RAL 7016²⁾ and CH 907 Grey aluminium²⁾ as well as in the surface finish Decograin³⁾ Golden Oak, Dark Oak and Titan Metallic CH 703 are also available on the inside in Traffic white RAL 9016, thus perfectly matching your white residential internal doors!

¹⁾ Not available for Thermo65 styles 100, 410, 430, 610.

²⁾ With angular A4 door frame

³⁾ With rounded A3 door frame

Frames and glazings

For more light in your home

Glazing frame for doors

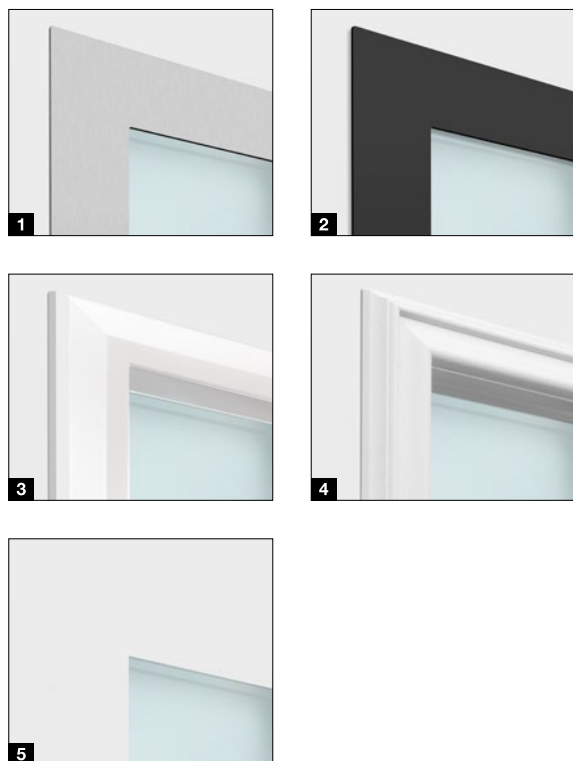

- 1 Stainless steel glazing frame**
With virtually flush-fitting appearance on the inside and outside with triple-pane insulated glazing: Thermo65 style 700 / 730 / 750 / 780 / 800 / 810 / 820 / 830 / 840 / 850 / 900 as well as Thermo46 style 700 / 750 / 900
- 2 Stainless steel glazing frame black.edition**
With elegant look in Jet black RAL 9005 with triple-pane insulated glazing: Thermo65 style 700 / 730
- 3 Plastic glazing frame "Roundstyle"**
For a modern, harmonious overall appearance. In a colour complementing the surface finish with Decograin surfaces. With double-pane insulated glazing: Thermo46 style 020 / 025 / 030 / 040
- 4 Plastic glazing frame "profile style"**
Perfectly matching the panelled door styles, with triple-pane insulated glazing: Thermo65 style 410 / 430. With double-pane insulated Cathedral glazing: Thermo46 style 200 / 400
- 5 Frameless**
Sophisticated appearance without glazing frame, with triple-pane insulated glazing: Thermo65 style 610 / 630

Glazings for doors, side elements and transom lights

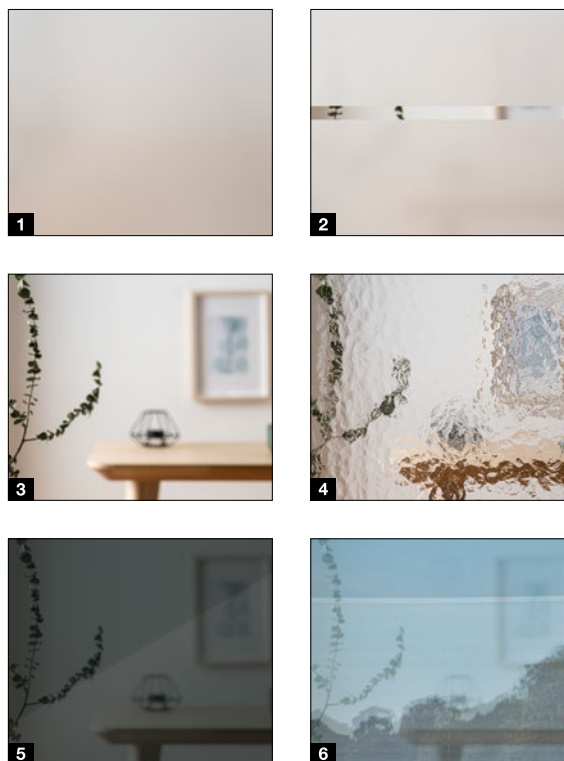

- 1** Satin-finished glass
- 2** Sand-blasted glass / sand-blasted glass with clear stripes
- 3** Clear glass
- 4** Cathedral glass with small hammered finish (only Thermo46)
- 5** **NEW.** Black glass (only Thermo65)
- 6** One-way plate glass
With reflection on the light side and a clear view from the dark side to the light side (Thermo65 only)

Safe glazing.

When it comes to industrial safety and burglar protection, Hörmann entrance doors meet the very highest standards. The safety glass on the interior and exterior of the insulated glazing provides maximum security. In case of glass breakage, the glass splinters are also bound on the inside, virtually eliminating any danger of being injured by the shards. Furthermore, the laminated safety glass offers better burglar protection as it makes reaching through more difficult.

Exterior handles and lever handle sets

A beautiful handle accents the door

Exterior handles



HB 14-2, brushed stainless steel

HB 38-2, brushed stainless steel

HB 38-2, black.edition, stainless steel Jet black RAL 9005 (for Thermo65)

HB 38-3, brushed stainless steel

HB 738, brushed stainless steel (for Thermo65 010, 610, 700, 750, 800)

NEW. HB 738, black.edition Stainless steel Jet black RAL 9005 (for Thermo65 010, 610, 700, 750, 800)

NEW. HB 739 Brushed stainless steel (for Thermo65 010, 600, 700, 750, 800)

Lever handle sets for outside and inside



Stainless steel lever handle set Type D-110



Lever handle set black.edition in Jet black RAL 9005 type D-110 (for Thermo65)



Stainless steel lever / knob handle set With knob type K-160, lever handle D-110



Lever / knob handle set black.edition in Jet black RAL 9005 with knob type K-160, lever handle D-110



Stainless steel lever handle set Type D-210



Stainless steel lever handle set Type D-310



Stainless steel lever handle set Type D-510



Lever / knob handle set ES 0 / ES 1 with knob (shown: ES 1 in stainless steel)



Lever handle set ES 0 / ES 1 (shown: ES 0 in stainless steel)

Automatic locks and electric extras

Smart security

Automatic lock with mechanical self-locking

(for Thermo65)

When the door falls shut, the bolts automatically extend and securely lock the entrance door.

Automatic lock with electric motor (for Thermo65)

Choose from three different opening options with radio, Bluetooth or intercom. You can additionally combine this lock with an optional integrated finger-scan. The lock locks the door automatically when the door is closed.

Opening via BiSecur radio: Open your entrance door easily and conveniently via a hand transmitter HSE 4 BS, radio code switch FCT 3-1 BS or radio finger-scan FFL 25 BS. There's no longer any danger of forgetting your keys. The lock locks the door automatically when the door is closed.

Opening via Bluetooth: You can open your door even more conveniently via Bluetooth using your smartphone with the user-friendly Hörmann BlueSecur app.

Opening via intercom: The automatic lock is simply connected to the intercom system via a volt-free contact.

Electric strike (for Thermo65 and Thermo46, not shown)

With the electric strike catch, you can conveniently open your door via a switch inside the house. When the day catch is set, light pressure from the outside is enough to open the door.

Reed contact / latch switching contact (for Thermo65 and Thermo46, not shown)

For connection to the building services or alarm system and evaluation that the door is closed (reed contact) or locked (latch switching contact).

Radio door lock operator SmartKey (for Thermo65 / Thermo46)

Easily open your door lock at the press of a button with your hand transmitter, radio internal push button or directly via the sensor field on the SmartKey. The automatic comfort lock ensures reliable and secure door locking. With the optional hand transmitter HS 5 BS or radio internal push button FIT 5, you can conveniently query whether the door is locked or unlocked – you no longer have to go to the door in the evening to check.

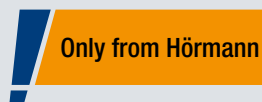

The automatic lock with electric motor and BiSecur radio system allows you to conveniently open your entrance door via a hand transmitter, radio code switch or radio finger-scan.

Another advantage is that you can use the same hand transmitter to operate your Hörmann garage door or entrance gate. The extremely secure radio system ensures that no unauthorised person can copy your radio signal. All operators, receivers and control elements with the BiSecur radio system are 100% compatible with each other.

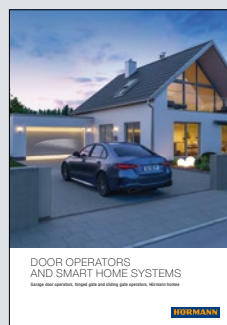

Further information on door operators and Smart Home systems can be found in the brochure.



Hand transmitter HSE 4 BS

4 button functions, incl. eyelet for key ring, textured surface black matt with plastic caps



Radio code switch FCT 3 BS

For 3 functions, with illuminated buttons, recessed or surface-mounted fitting possible, plastic housing in Light grey RAL 7040



Radio finger-scan FFL 25 BS

For 2 functions and up to 25 fingerprints, with hinged cover, recessed and surface-mounted fitting possible, plastic housing painted in RAL 9006 White aluminium



Finger-scan elegantly integrated in the door leaf

Fitting on the door leaf, for up to 150 fingerprints, VDS-approved, dimensions: 45 x 75 mm, optional for all automatic locks with electric motor

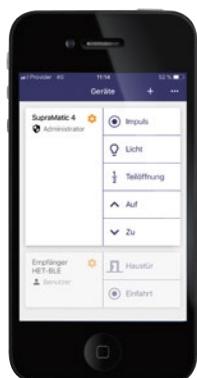

Bluetooth receiver

For operation by smartphone using the Hörmann BlueSecur app



Radio door lock operator SmartKey

Available in white or silver, incl. hand transmitter HSE 4 SK BS with labelled buttons

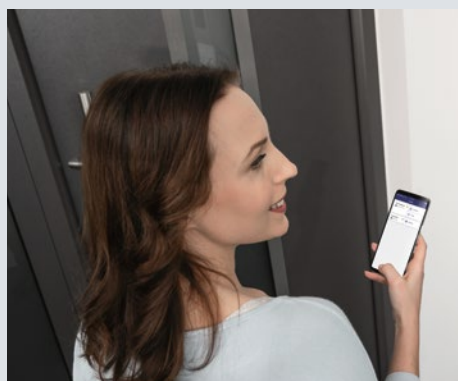

Hörmann BlueSecur

Only from Hörmann

European patent

Conveniently open and close your door via Bluetooth using your smartphone. Lock and unlock your entrance door using the user-friendly Hörmann BlueSecur app. In addition, other user permissions can be permanently or temporarily transferred to other smartphones, so that every family member always has their "entrance door opener" with them.

Dimensions and technical manual

Thermo65 / Thermo46

Thermo65* standard sizes

Overall frame dimension (ordering size)	Structural opening	Clear frame dimension
1000 x 2100	1020 x 2110	850 x 2005
1100 x 2100	1120 x 2110	950 x 2005
1150 x 2200	1170 x 2210	1000 x 2105

Thermo46 standard sizes

Overall frame dimension (ordering size)	Structural opening	Clear frame dimension
1000 x 2100	1020 x 2110	872 x 2016
1100 x 2100	1120 x 2110	972 x 2016
1150 x 2200	1170 x 2210	1022 x 2116

Special sizes Thermo65 / Thermo46*

Styles	Overall frame dimension (ordering size)
200	875 – 1100 x 1990 – 2186
010, 020, 030, 040, 600, 700, 730, 750, 800, 810, 840	700 – 1250 x 1875 – 2250
015, 025, 515, 780	875 – 1250 x 1875 – 2250
100, 400, 410, 430	875 – 1100 x 1875 – 2186
820, 830, 850, 900	800 – 1250 x 1875 – 2250
610, 630	875 – 1250 x 2000 – 2250

* For double-leaf entrance doors, the traffic leaf is ordered as a standard / special size, the fixed leaf is always a special size.

Horizontal view of door, Thermo65

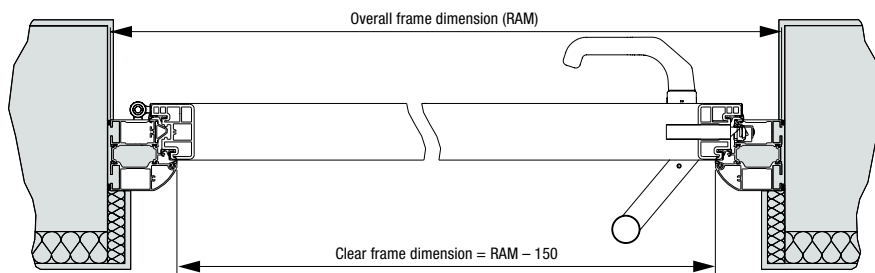

Vertical view of door, Thermo65

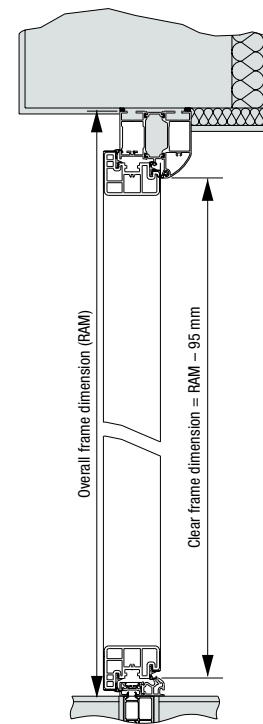

Horizontal view of side element, Thermo65

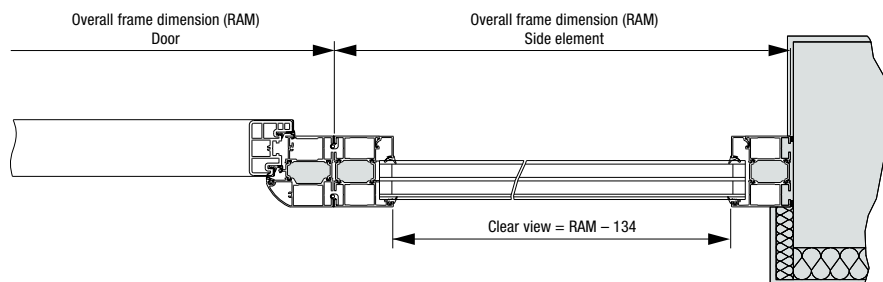

Frame variants, Thermo65

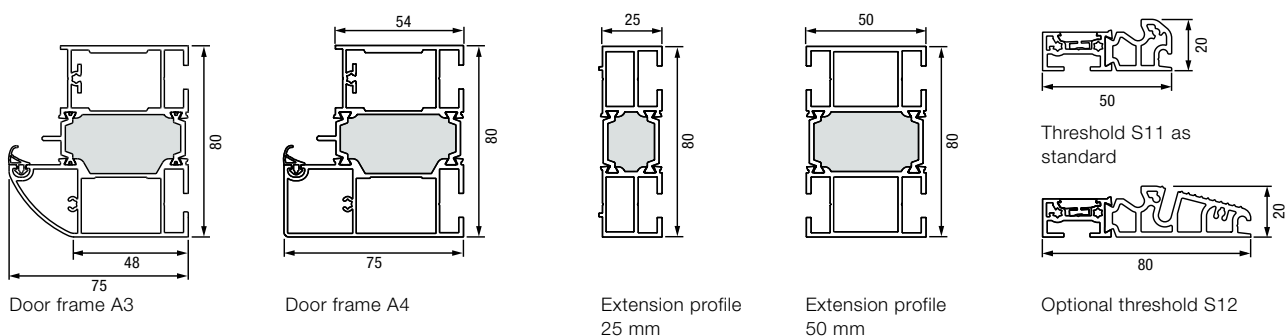

Side element standard sizes

Version	Overall frame dimension (ordering size)
Thermo65 / Thermo46	400 × 2100 400 × 2200

Side element special sizes

Versions	Overall frame dimension (ordering size)
Thermo46 Thermo65	300 – 1000* × 700 – 2250 300 – 1000* × 700 – 2250

* Transom light not possible from a width of 500 mm. Door sets with side elements do not contribute to the static equilibrium, which must be guaranteed by the building structure.

Transom light special sizes

Version	Overall frame dimension (ordering size)
Thermo65 / Thermo46	700 – 2250 × 300 – 500

Horizontal view of door, Thermo46

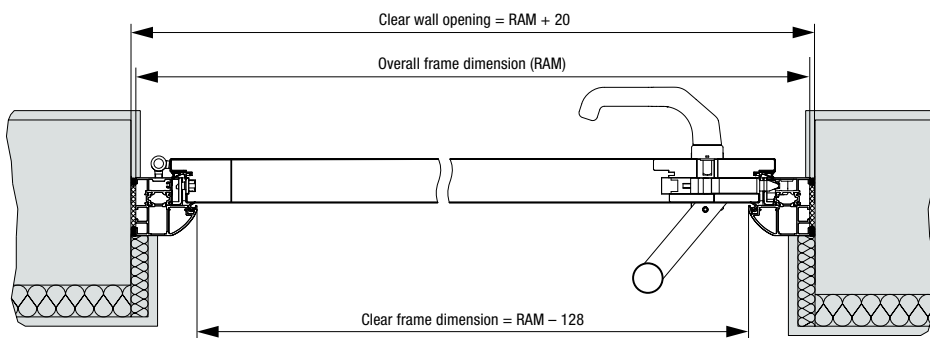

Vertical view of door, Thermo46

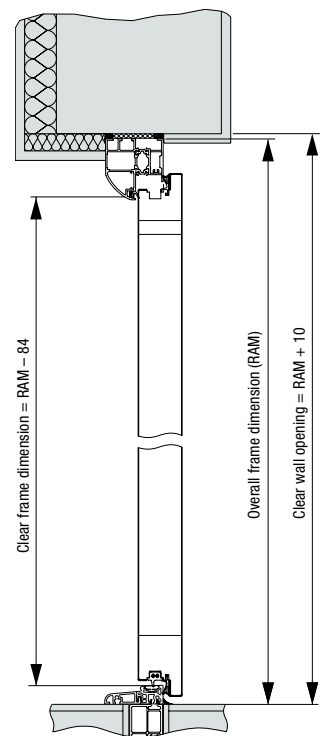

Horizontal view of side element, Thermo46

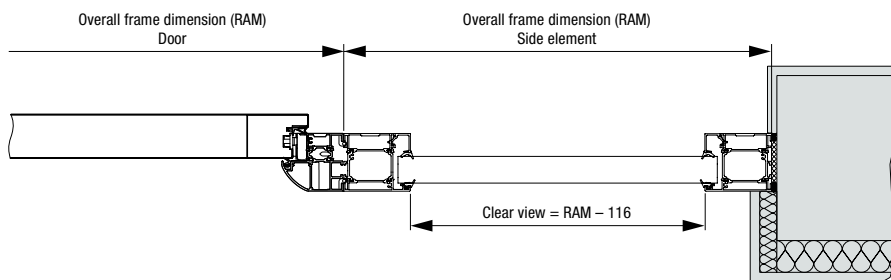

Frame variants, Thermo46

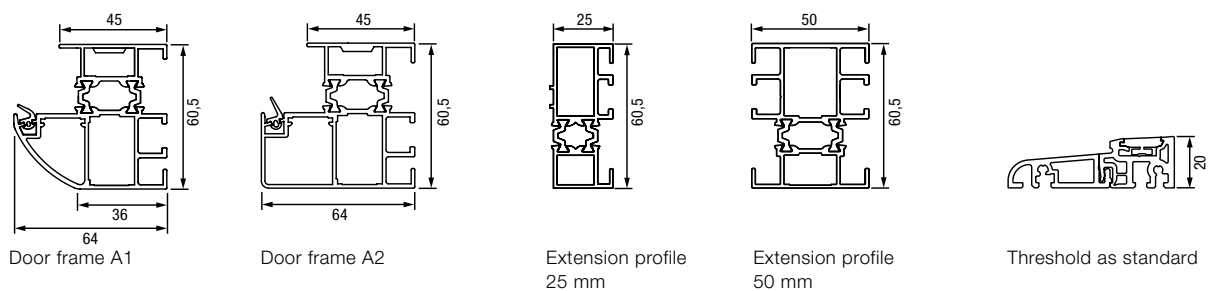

Experience Hörmann quality in new construction and modernisation

Hörmann products have impressive durability and high functionality. You can easily plan for new construction as well as modernisation. The carefully coordinated solutions make your home more beautiful, more secure and more comfortable.

GARAGE DOORS. GATE AND DOOR OPERATORS. ENTRANCE DOORS. RESIDENTIAL INTERNAL DOORS. STEEL DOORS. DOOR FRAMES. STORAGE SPACE SYSTEMS.



Some of the products shown feature special equipment and do not always correspond to the standard versions. The surface finishes and colours shown are subject to the limitations of the printing process and cannot be regarded as binding. All RAL colours are based on the RAL colour chart. All rights reserved. No part may be reproduced without our prior permission. Subject to changes.